

TASK	Search the word Solve the rebus	ANSWER	Nightingale
-------------	------------------------------------	---------------	--------------------

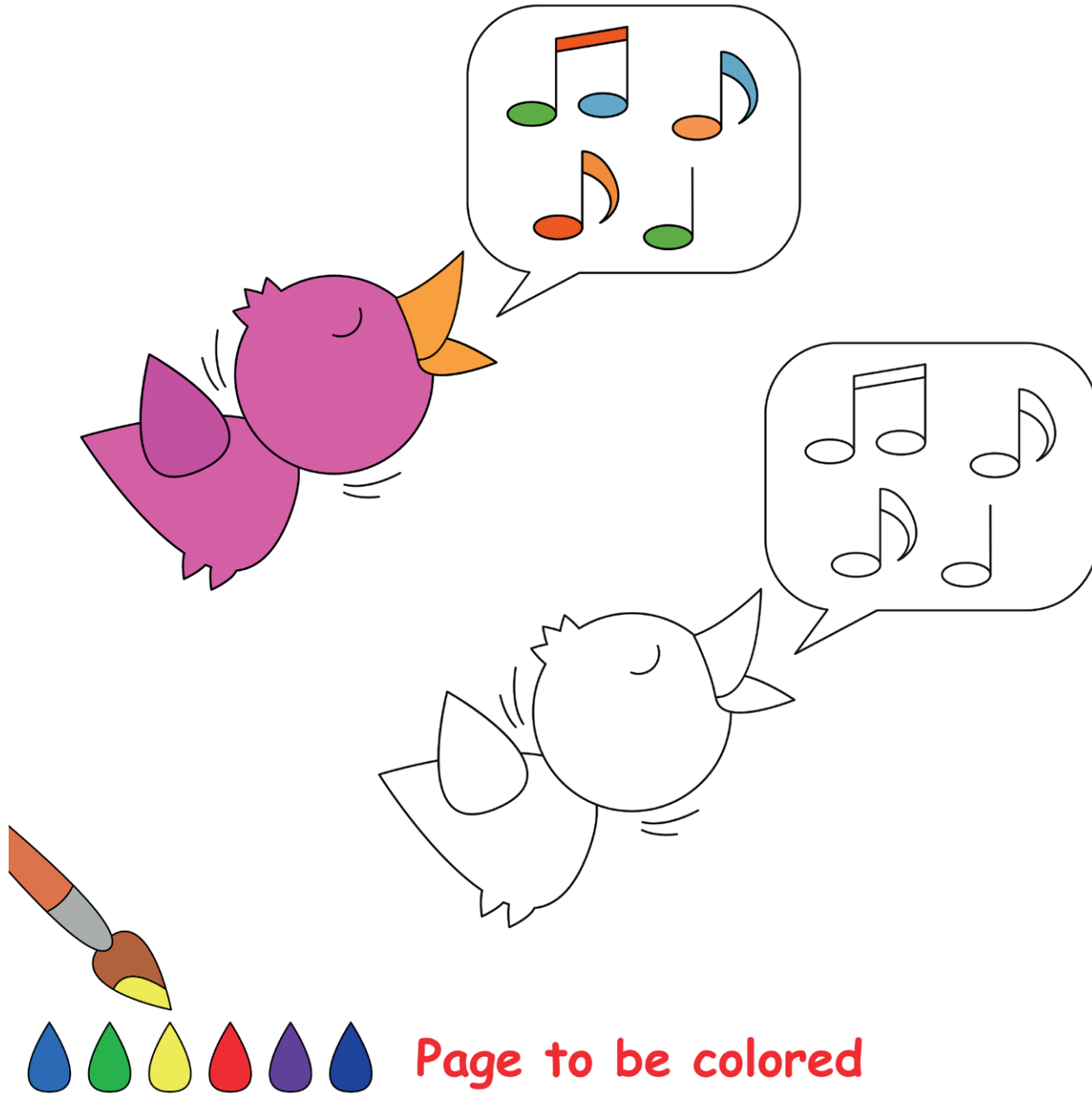

Page to be colored

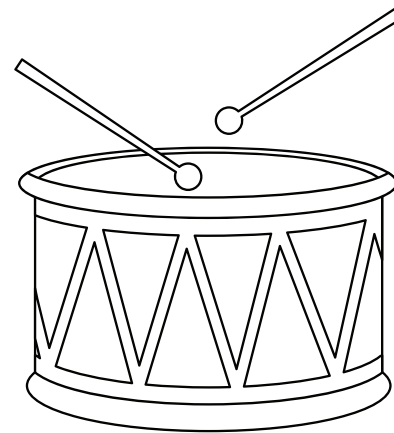
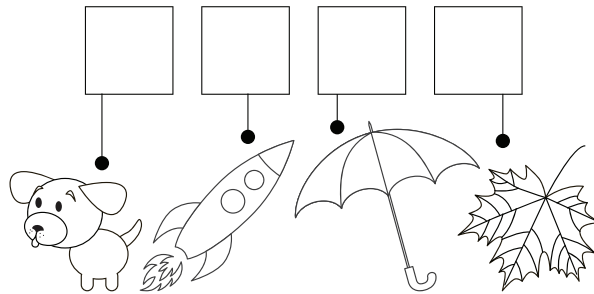
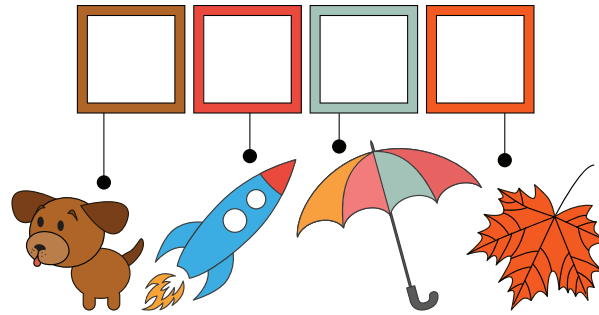
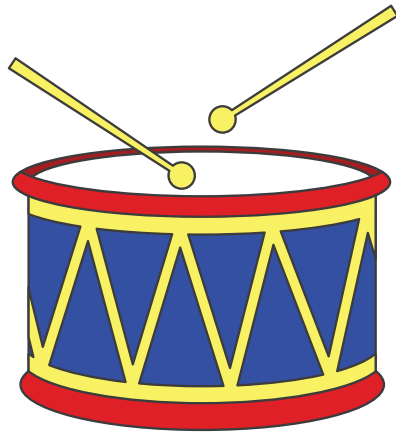

TASK

**Search the word
Solve the rebus**

ANSWER

Drum

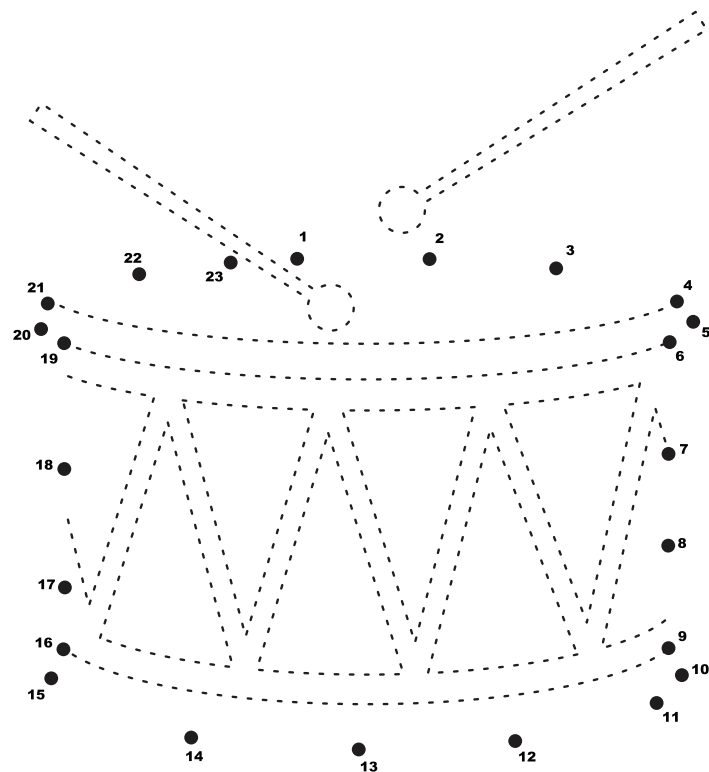
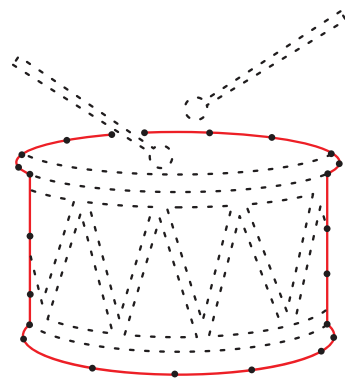

TASK

**Connect the dots
Color the picture by sample**

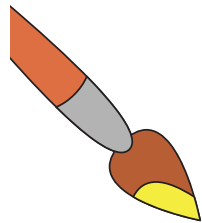
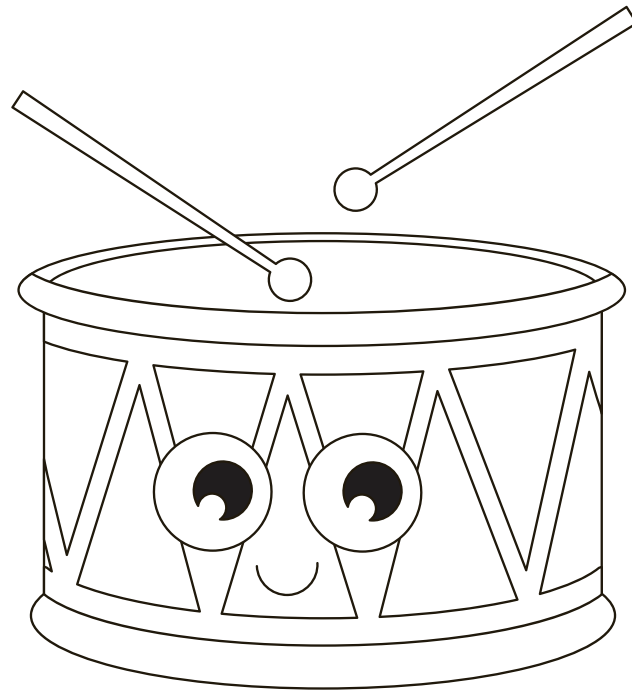
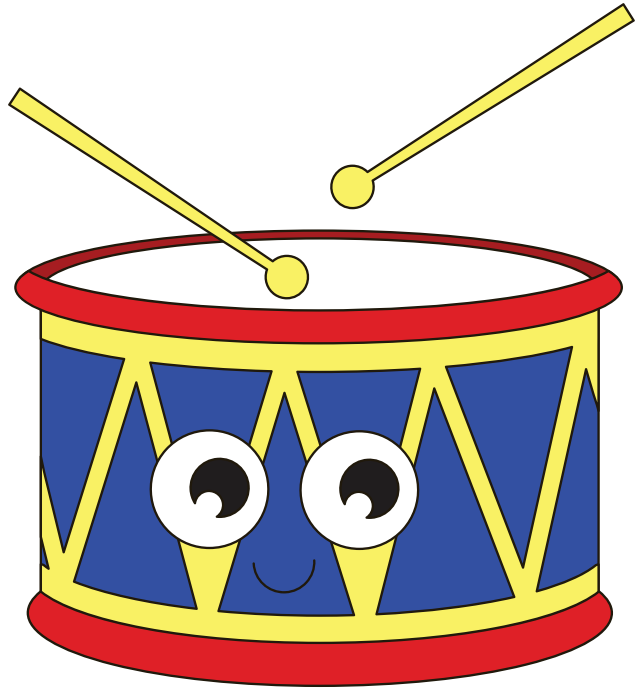

Page to be colored

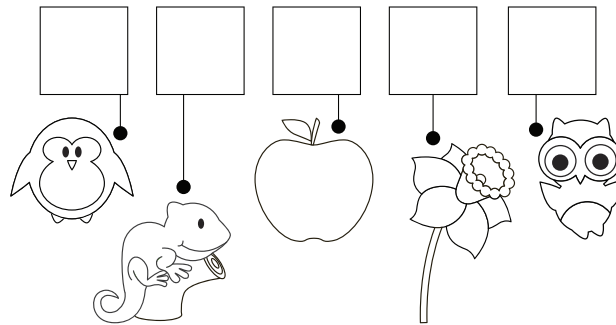
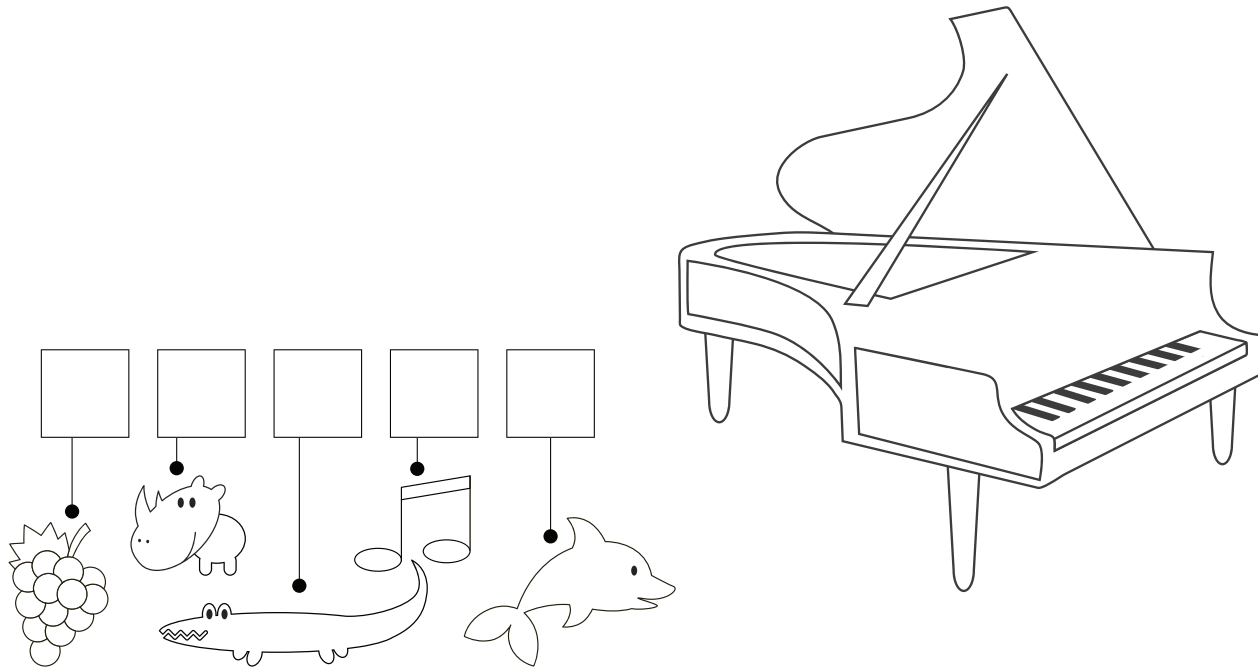

TASK	Search the word Solve the rebus	ANSWER	Grand piano
-------------	------------------------------------	---------------	------------------------

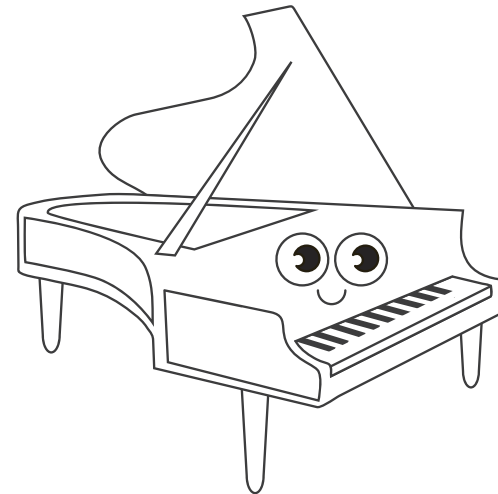
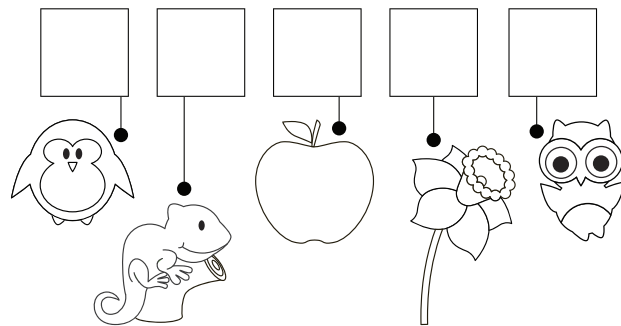
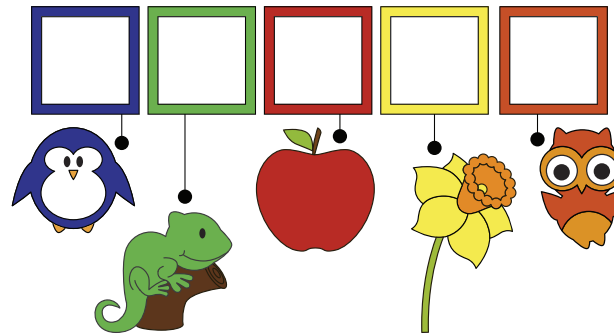

TASK	Search the word Solve the rebus	ANSWER	Piano
-------------	------------------------------------	---------------	--------------

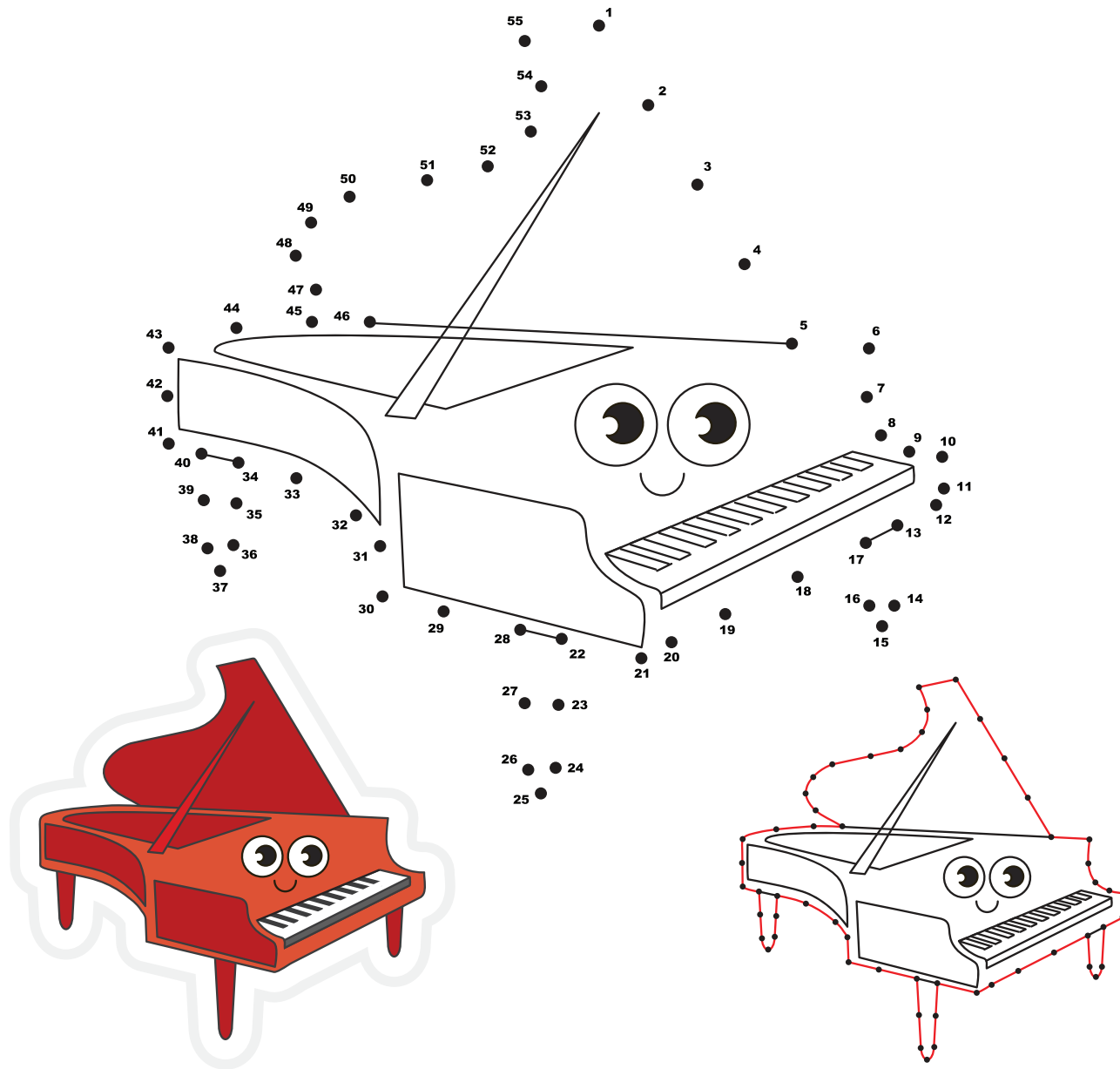

TASK

**Connect the dots
Color the picture by sample**

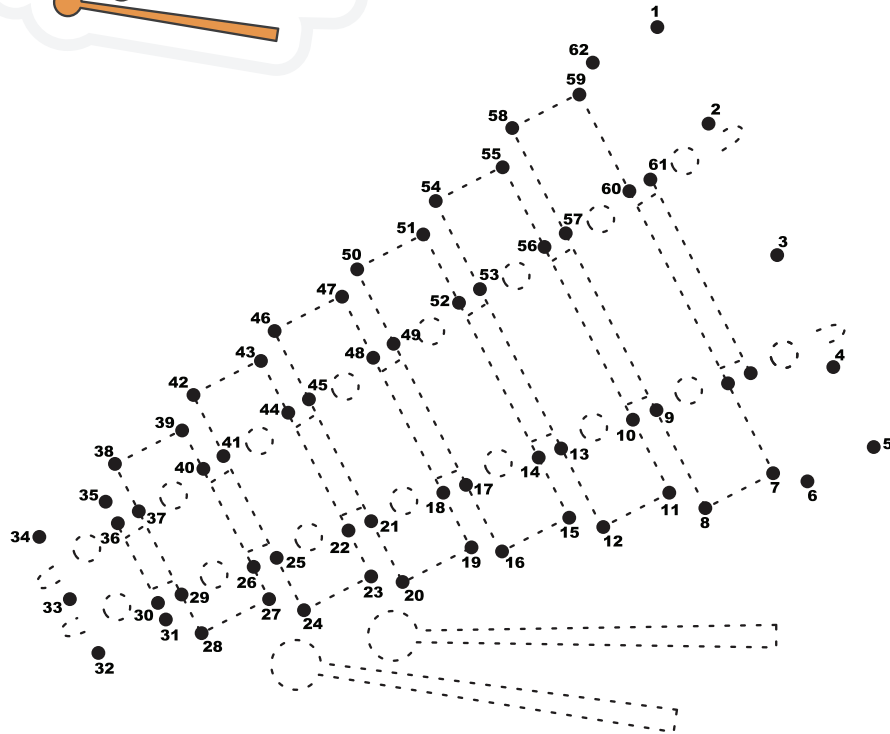
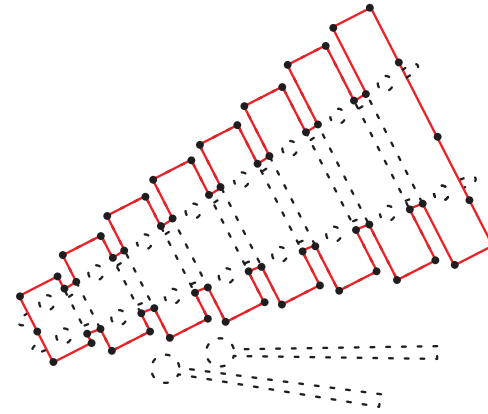
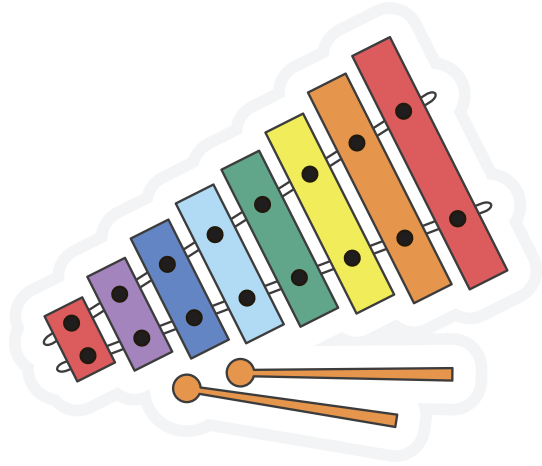

TASK | **Connect the dots**
Color the picture by sample

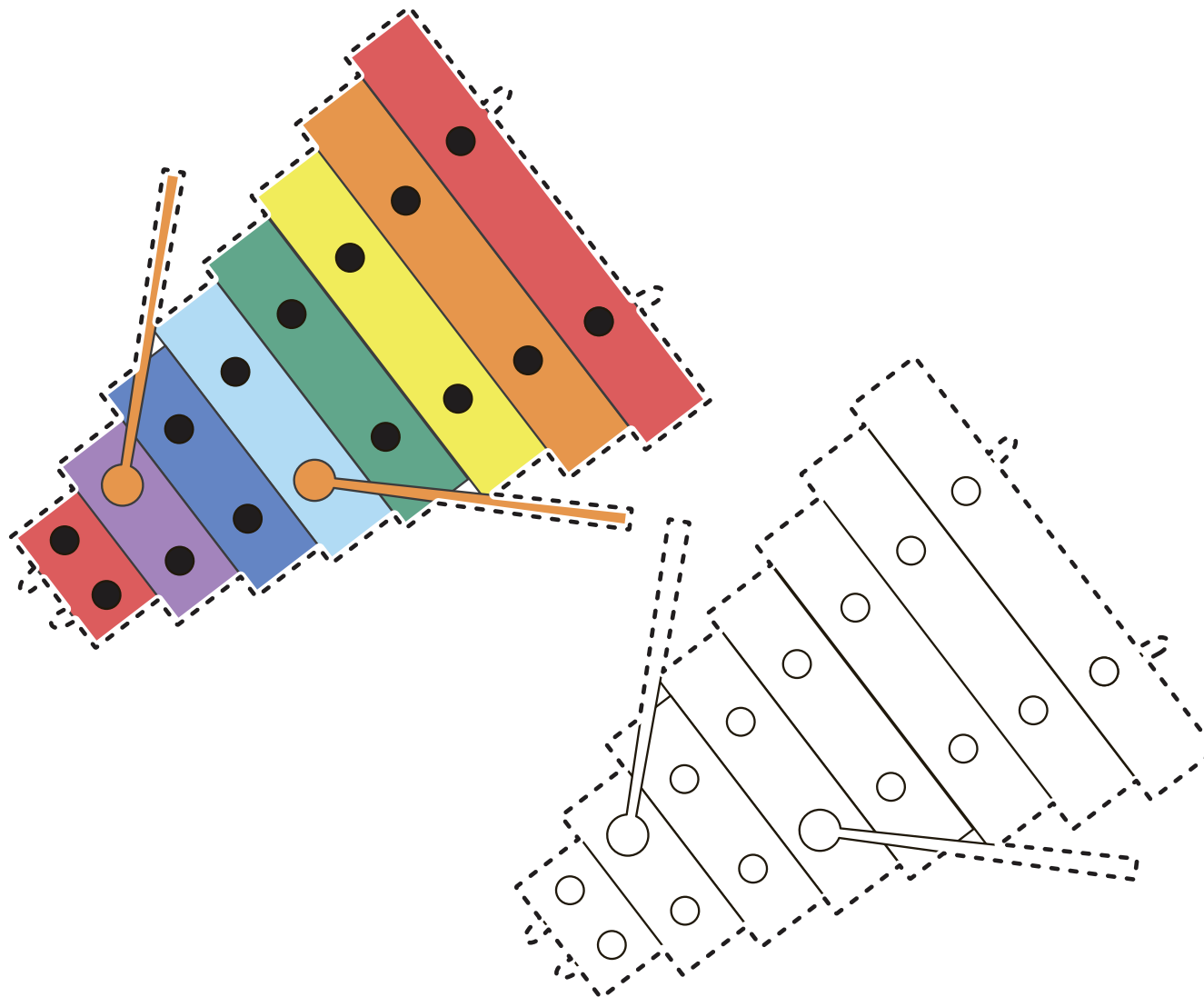

Trace the picture only of ONE LINE!

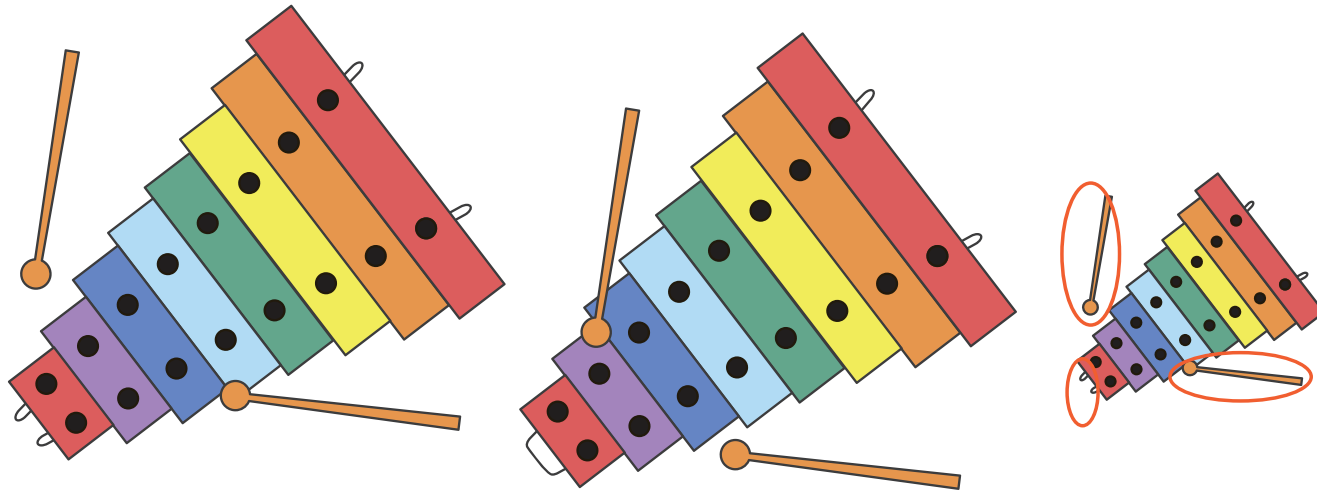

Find 3 differences

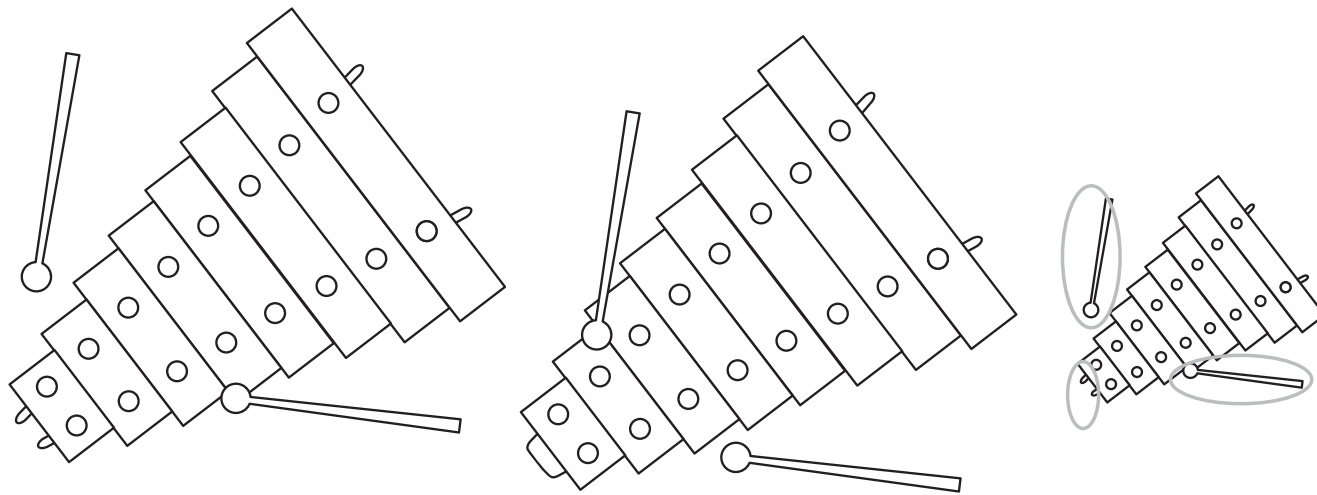

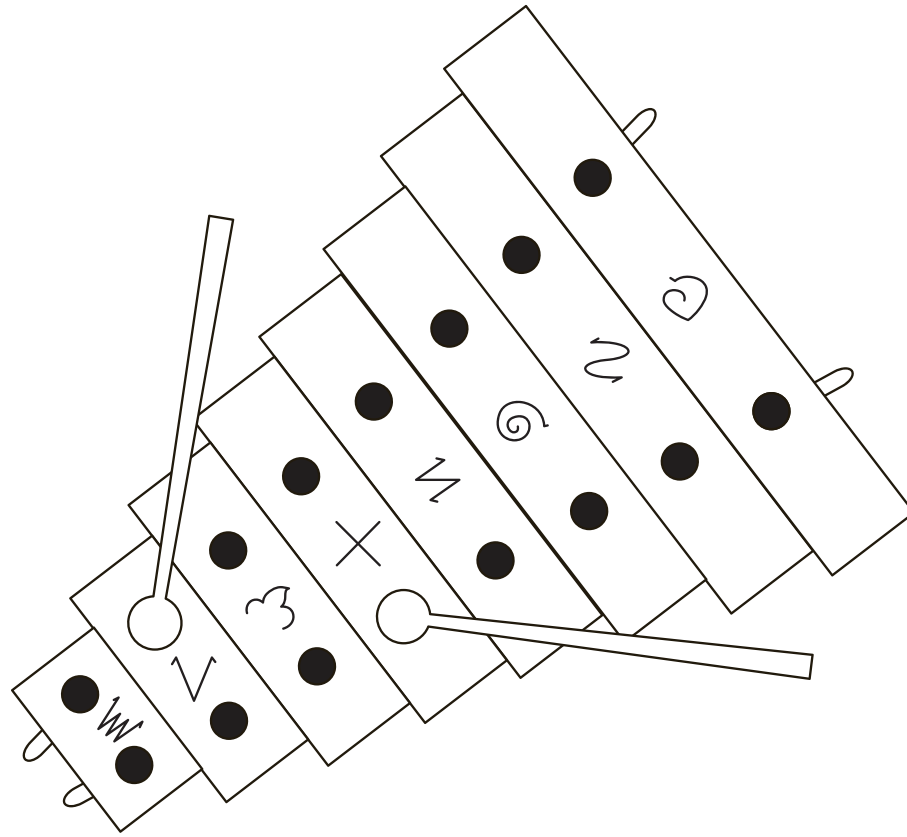

Page to be colored using signs

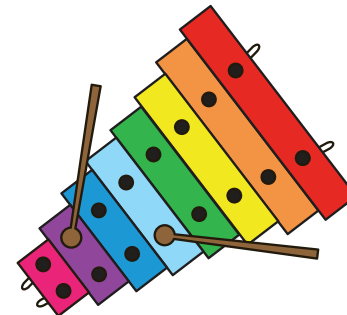
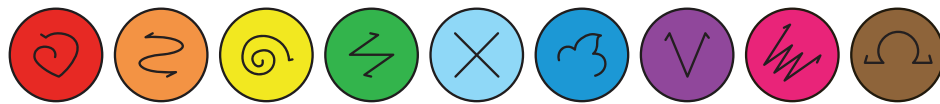

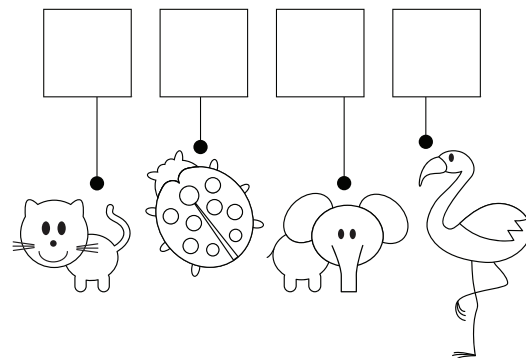
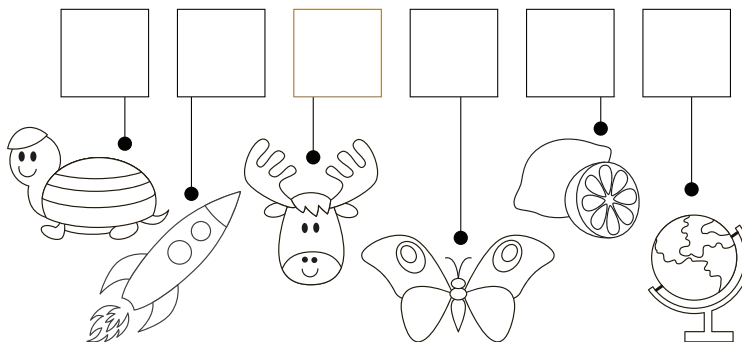
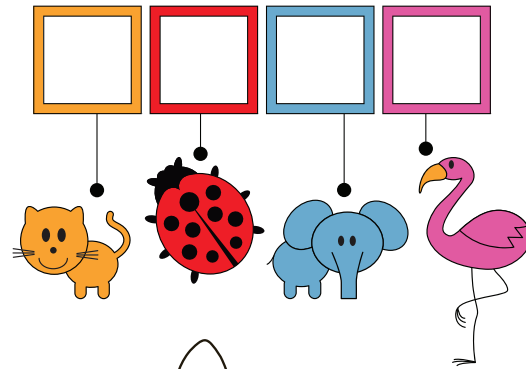
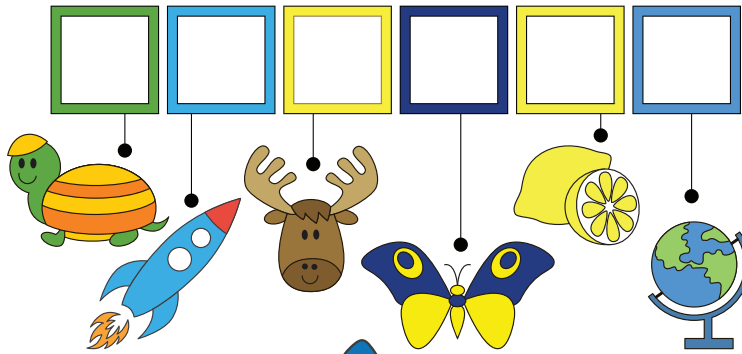

TASK	Search the word Solve the rebus	ANSWER	Treble Clef
-------------	------------------------------------	---------------	------------------------

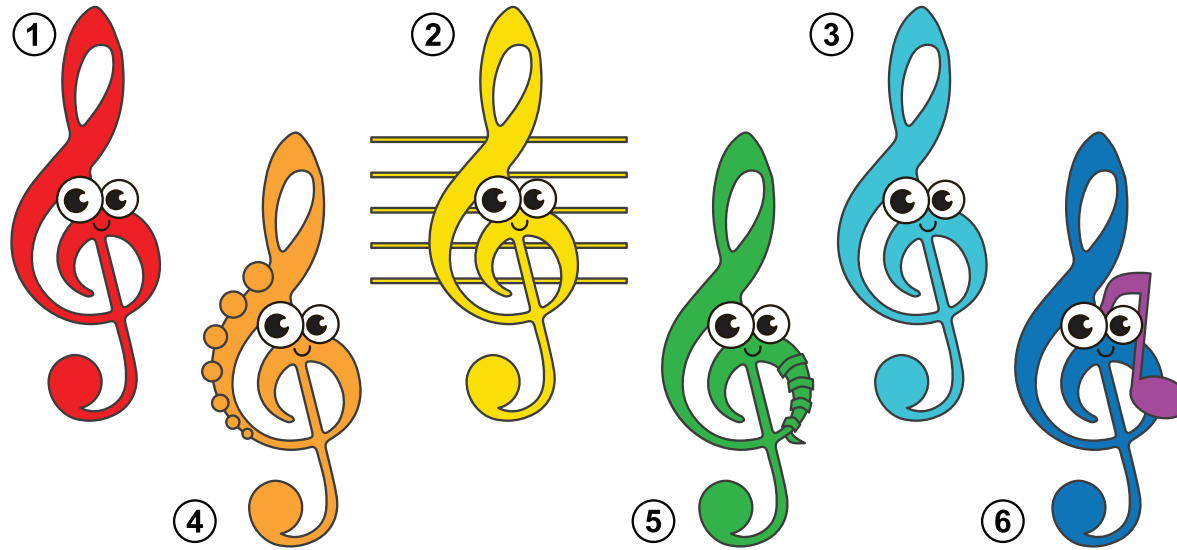

Find two identical images. Answer: 1, 3

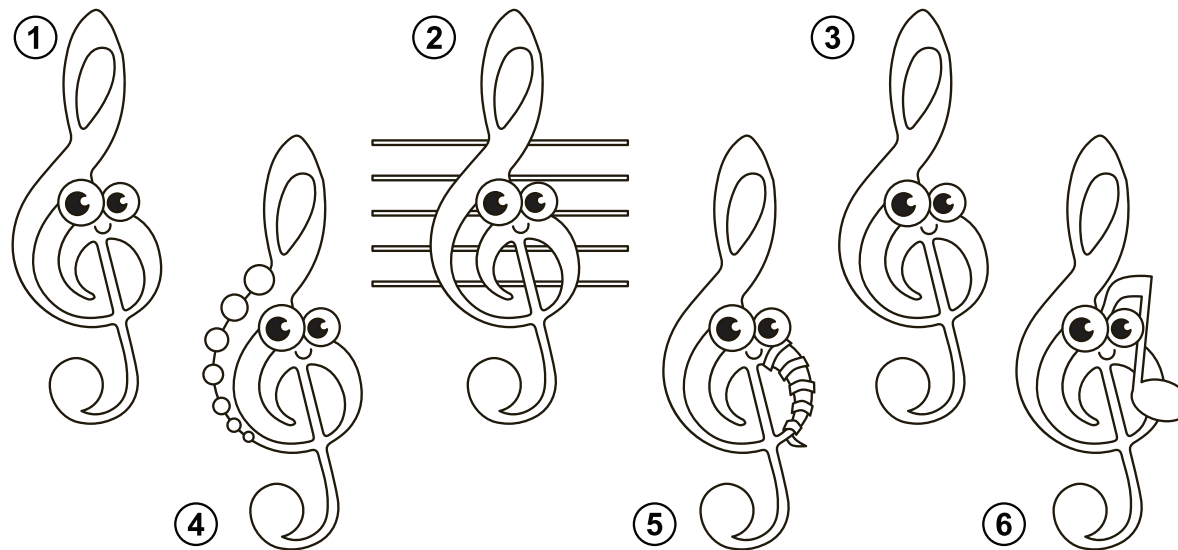

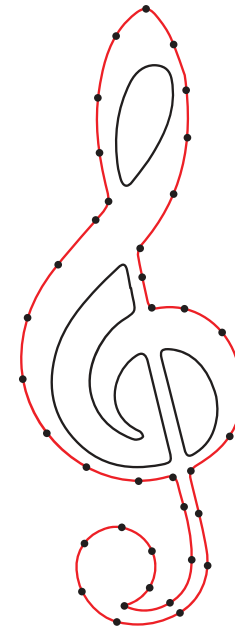
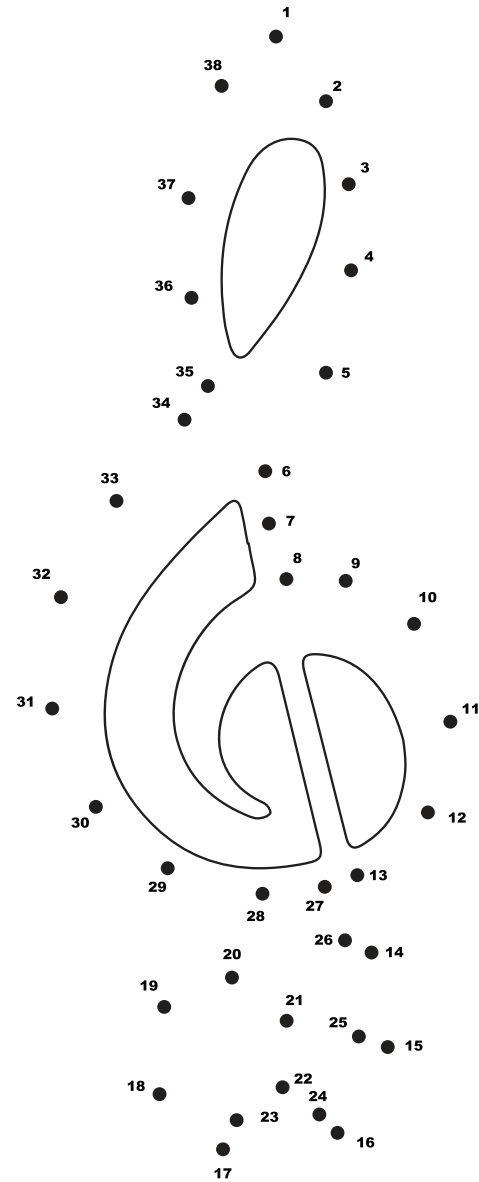

TASK

**Connect the dots
Color the picture by sample**